

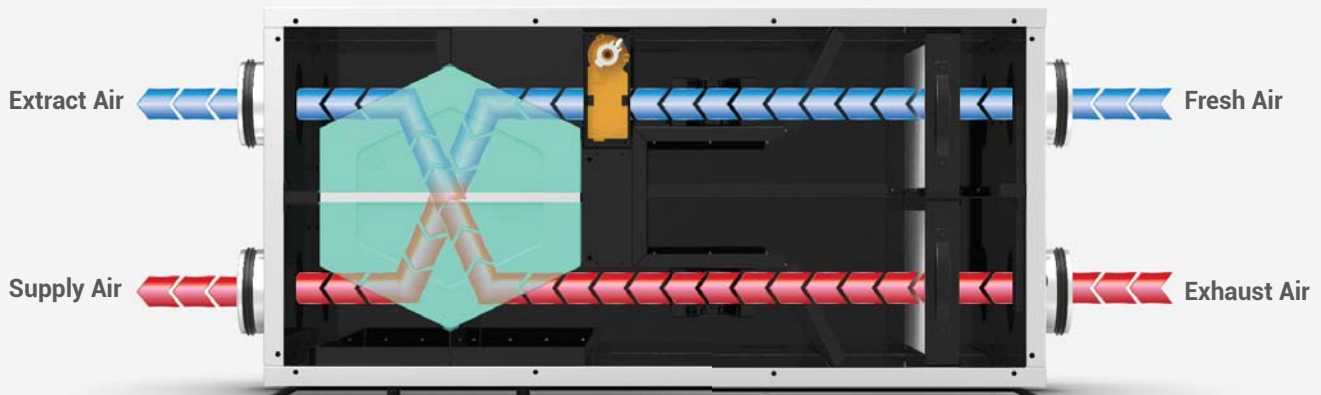

**RESIDENTIAL HIGH EFFICIENCY  
HEAT RECOVERY UNITS**



## BSK BRHR HEAT RECOVERY DEVICE



The importance of keeping the humidity and temperature of our living spaces at a reasonable level is crucial for both our health and comfort. Moisture and bad odors will build up in poorly ventilated rooms, which creates suitable conditions for the growth of harmful organisms such as bacteria and mold. Also, infectious diseases spread easier in poorly ventilated spaces. For this reason, we should constantly ventilate the spaces we use to prevent such undesirable situations.

Modern buildings with increased thermal insulation also restrict the natural ventilation in order to prevent heat loss through air leakages from under doors, window sills, wall plasters etc. This is not a problem for commercial buildings with central ventilation systems, yet the ventilation task remains on opening windows and balcony doors in residential buildings. Opening windows and doors may be practical in warmer days, but on cold ones, to get fresh air means to fill the room with cold air, which needs to be heated again. Heat recovery devices are fully developed ventilation systems created to solve this problem by transferring the heat from warm inside air to the cold outside air.

Heat recovery devices are fresh air ventilation devices that work with the principle of transferring the energy between the fresh air and exhaust air. Generally, hot exhaust air is used to heat up the cold fresh air but since this heat transfer takes place in a passive heat exchanger, the fresh air can be cooled in summer too. Since plastic plate heat exchangers are used, fresh and exhaust air does not mix with each other and, 100% fresh air is provided to the indoor environment.

We use highly efficient plastic plate heat exchangers in BSK residential heat recovery units. The two air streams passing through the plastic plates of the heat exchangers do not mix thanks to the seals fused with ultrasonic vibrations. 100% fresh air is provided to the house with thermal efficiencies reaching up to 95%, thanks to the counter-flow nature of the heat exchangers. To give an example; at 90% efficiency, with an outside temperature of 0°C and an inside temperature of 22°C, the supply air temperature will be about 2°C, which the fresh air is heated up using only the energy from exhaust air.

## BSK BRHR HEAT RECOVERY DEVICE

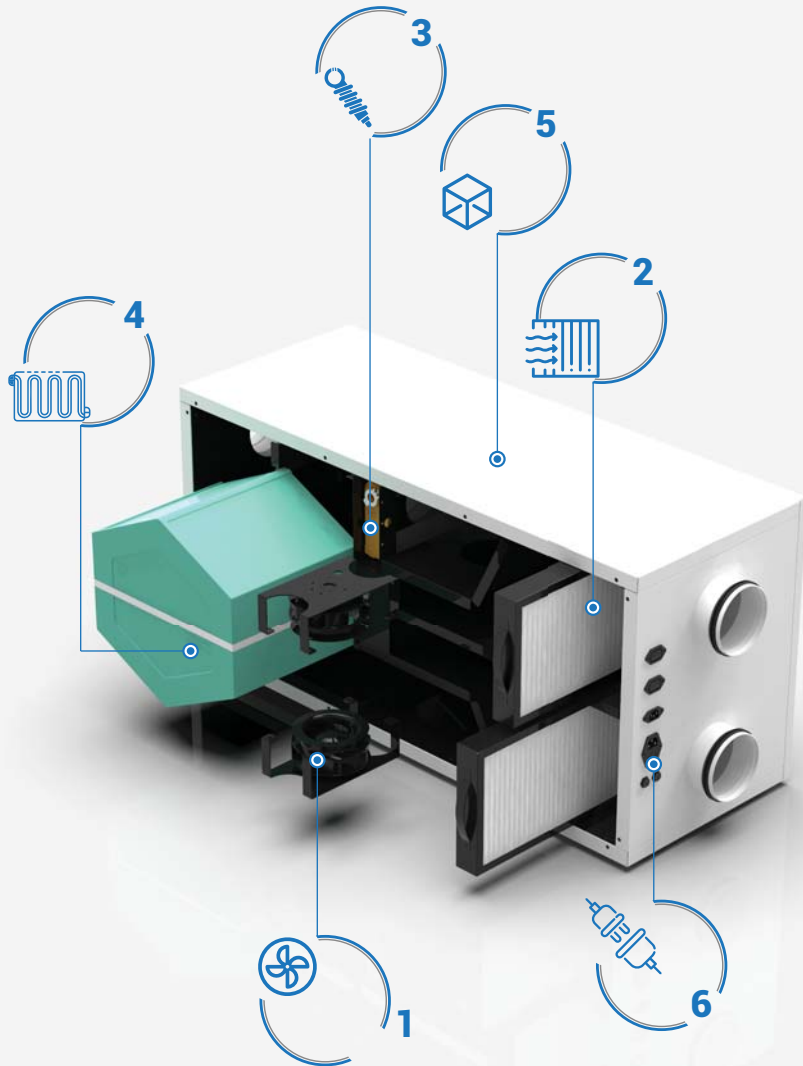

### 1 EC Fans

High efficiency EC motor fans are used in our devices. EC motors can be operated at any desired speed thanks to their built-in control circuits. With their advanced control mechanisms, they consume much less electricity than ordinary AC motors. Reverse blade inclined fans, offer maximum performance while minimizing sound levels.

### 2 Filters

To increase the air quality and protect the performance of your BSK Heat Recovery Unit, we equip two G4 panel filters, in accompany of EN 799 filter standards, to the air intake vents. Built-in pressure sensors will notify you when the filters are full and needs a change. With our easy-to-use slotted design, all you need to do is open the cover panel and swap filters. If you need allergy protection, optional F7 pollen filters are also available on request.

### 3 Bypass damper

All of our devices have standard by-pass duct and damper, which in free-cooling conditions divert the air directly to your home without passing through the heat exchanger. You can set the temperature you want this feature to activate, and it will be controlled automatically when the desired conditions are met in the spring months when indoor and outdoor conditions are close to each other.

### Free-cooling

On seasonal transitions (spring and autumn) when indoor and outdoor temperature differences are not significant, BSK Heat Recovery Units automatically switch to Free Cooling mode by opening the built-in bypass vent. The air will pass through this canal without going through the heat exchanger, thus reducing the pressure on fans and operate on a more efficient state.

### Defrost Modu

To prevent frost formation inside the device our devices automatically enter defrost mode when temperature conditions drops below zero. Defrost mode adjusts intake and exhaust air rates periodically to prevent icing and keep the device temperature at operating levels. We strongly advise you to use a pre-heater for climate conditions below -10 C for prolonged times.

## 4 Heat Exchanger

High efficiency plastic plate heat exchangers in our units are where heat recovery takes place. Thanks to its plastic plate structure, no mixing occurs between the exhaust and fresh air. They operate with the counter flow principle, which can achieve thermal efficiencies of up to 95% between hot and cold air.

## 5 Metal Frame

The metal frame of our devices made of 0.7mm galvanized sheet, outer case is double-walled and filled with 25mm rock wool insulation material in order to keep the sound and heat insulation at the highest level in order to offer you a comfortable experience. All surfaces, including the inside too, are painted with electrostatic powder paint to ensure a long life and a pleasant view.

## 6 Plug-and-play Connections

All electrical connections of our devices are provided from the sockets on the case. You can use these sockets right out of the box without having to call an electrician or technician to make their connections. All you have to do is plug the corresponding accessory's cable into its socket.

## BSK VENTI HEAT RECOVERY DEVICE

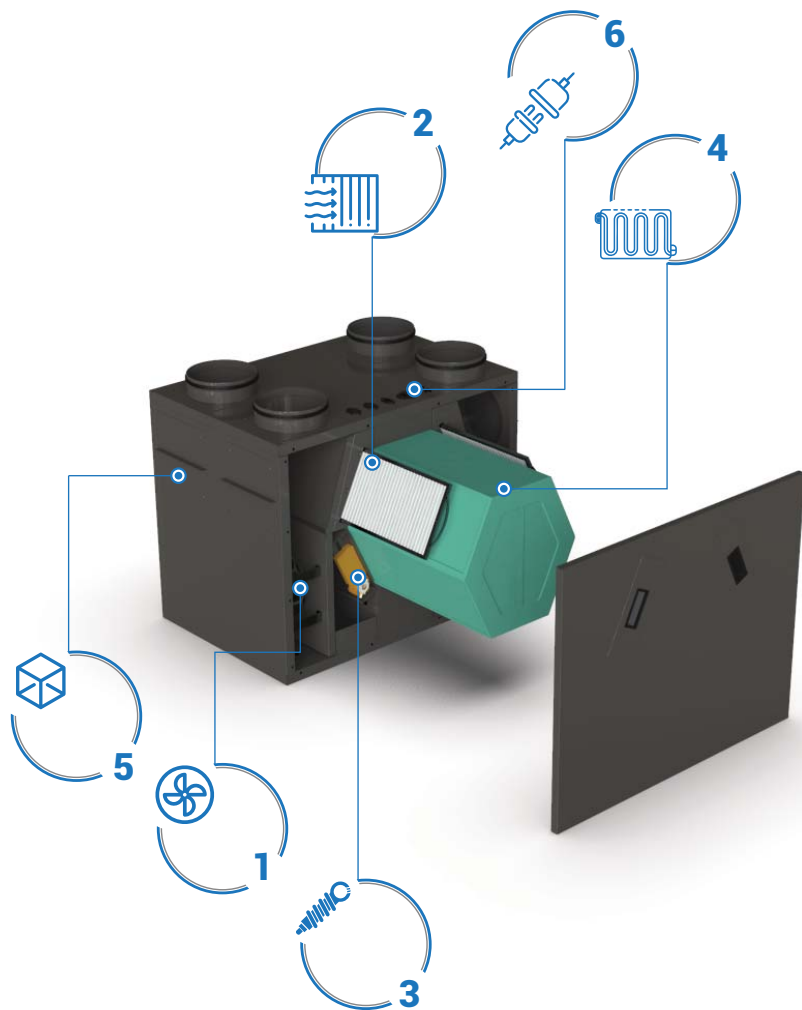

### Humidity Control

Thanks to the humidity sensor in our devices, the humidity level of the return air is controlled. When this humidity value determined by the user is exceeded, the device will automatically increase the speed of the aspirator fan and immediately evacuate the humid air in the environment. When the humidity level decreases, the device returns to resume operation.

### Kitchen Hood Connection

You can connect the device to the kitchen hood (or a wall switch) using the Boost input port on the device. If the kitchen hood is on, our heat recovery device will enter boost mode and adjust the fan speeds to a desired level set by the user.



### ModBus Compatible

Our units use ModBus protocol to connect and communicate with each other and/or your building management system and allows control and monitoring of your device through a computer or a central system.

## CONTROL FEATURES



BSK heat recovery units can come with different control panel options. Depending on the model you want there may be some functions not available, or different. The manual control panel offers essential features with simple control options. Boost mode and free-cooling mode is automated however the set temperature for free cooling is predefined and cannot be changed by users. Digital control panel offers extended controlling options and supports more accessories to be connected. You can also choose to have a Wi-Fi enabled digital control panel and use our new mobile application to gain access to all the controlling options and can control your device from anywhere.

	 Manual Control Panel	 Digital Control Panel	 WiFi Control Panel
Fan speed control	•	•	•
Individual fan speed control		•	•
Bypass damper for free-cooling mode	•	•	•
Set temperature		•	•
Filter alarm	LED light	Panel notification	Mobile notification
Humidity boost mode	•	•	•
Kitchen boost mode	•	•	•
Manuel boost mode		•	•
Fresh air sensor	Temperature sensor	Temperature sensor	Temperature and humidity sensor
Return air sensor	Humidity sensor	Humidity sensor	Temperature and humidity sensor
Supply air sensor			Temperature and humidity sensor
Room panel sensor		Temperature sensor	Temperature sensor
CO <sub>2</sub> sensor (*)		•	•
Automatic defrost mode		•	•
Automatic pre-heater control (*)		•	•
Last heater control (*)		•	•
Automatic mode		•	•
Weekly schedule		•	•
ModBus connection		•	•
Wi-Fi connection			•
Mobile application			•
Usage statistics			•

"\*" Optional

## MOBILE APPLICATION



With our new wi-fi enabled control option and mobile app, BSK heat recovery devices are IoT ready and will be a great addition for smart homes. Now you can control your device from anywhere with your phone, our new app; BSK Connect, is available for both Android and iOS devices. Gain access to a wide range of control options and user statistics with a touch of a finger.

- Fan speed controls
- Heater control
- Boost mode settings and control
- Weekly schedule
- Historical usage info and statistics
- Filter level and warnings
- Multiple device connection

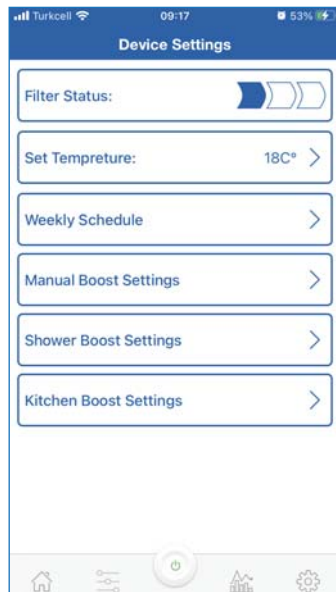

Download on the  
App Store



GET IT ON  
Google Play

## OPTIONAL ACCESSORIES

### Pre-heater



For subzero outside conditions, you should equip an electrical pre-heater to prevent ice forming inside the unit. This electrical pre-heater can connect to your BSK Heat Recovery Unit's fresh air intake vent.

### Water Heater

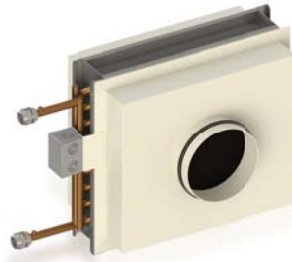

If your house is already heated by hot water, you can equip duct type water coils to the supply air vent to further heat the incoming air for a precise control of temperature. For buildings without the option for a water heater, we also offer electrical heaters.

### CO2 Sensor



CO2 sensor allows automatic control for ventilation rate in crowded venues or houses with fireplaces. When the CO2 levels rise, your BSK Heat Recovery Unit increases ventilation rate to supply you with the best air quality.

### F7 Filter



Our standard G4 filters offers good protection against dust and common particles, however you may need additional protection from pollens and other smaller particles especially if residents are allergic. We suggest the F7 grade pollen filters for such individuals.

### Silencer



We designed BSK Heat Recovery Units to be as quiet as possible; however you may need to further reduce the noise levels in some situations. You can add the duct type silencer or the flexible silencer for those tight spaces, to the supply vent and enjoy the silence.

### Drainage Siphon



Condensation inside the BSK Heat Recovery Unit is kept at a minimum but varying humidity and temperature levels may increase the precipitation. With this apparatus you can connect your unit to your existing water system and get rid of the water droplets hassle free.



## BSK RESIDENTIAL HEAT RECOVERY UNITS ECODESIGN AND TECHNICAL SPECIFICATIONS

Manufacturer	BSK Havalandırma Ekipmanları AŞ								
Product Model	BRHR 150 Slim	BRHR 100	BRHR 150	BRHR 180	BRHR 220	BRHR 325	Venti 400	Venti 500	
SEC Class	A+								
*SEC (Average)	-42.81	-43.56	-43.74	-43.95	-42.63	-43.27	-43.22	-42.9	kWh/(m <sup>2</sup> .a)
SEC (Cold)	-82.14	-83.2	-83.56	-83.96	-81.66	-82.5	-82.53	-81.91	kWh/(m <sup>2</sup> .a)
SEC (Warm)	-17.65	-18.23	-18.31	-18.4	-17.65	-18.18	-18.07	-17.93	kWh/(m <sup>2</sup> .a)
Product Type	Bidirectional Residential Heat Recovery Unit								
Drive Type	Variable Speed Drive (VRS)								
Type of HRS	Recuperative								
Thermal efficiency of HRS	90.1	91.5	92.3	93.2	88.7	89.6	90	88.6	%
Max. Flow Rate (@ 100 Pa)	160	175	185	185	440	500	560	700	m <sup>3</sup> /h
Max. Electrical Power	60	60	60	60	170	170	240	330	W
Sound Power Level (Lwa)	37								
Reference flow rate	0.035	0.038	0.040	0.040	0.090	0.100	0.110	0.140	m <sup>3</sup> /s
Reference external pressure	50								
*SPI (@ Ref. flow & pressure)	0.24	0.21	0.21	0.21	0.23	0.2	0.21	0.21	W/(m <sup>3</sup> /h)
Control Type	Local Demand Control								
Control factor	0.65								
Internal / External leakage rate	< 2								
Casing leakage class	L1								
Visual filter warning	Yes (See User Manual for details)								
Assembly instructions	www.bskhvac.com.tr								
*AEC (Average)	1.85	1.67	1.67	1.67	1.79	1.61	1.67	1.67	kWh/a
*AHS (Average)	46.75	47.07	47.25	47.46	46.43	46.64	46.73	46.41	kWh
AHS (Cold)	91.45	92.08	92.43	92.84	90.83	91.23	91.41	90.79	kWh
AHS (Warm)	21.14	21.28	21.37	21.46	21	21.09	21.13	20.99	kWh

\* AEC: Annual Electricity Consumption, AHS: Annual Heat Savings, SEC: Specific Energy Consumption, SPI: Specific Power Input  
This document is prepared in accordance with the Commission Delegated Regulation (EU) No 1254/2014 and EN 308:1997

**BSK BRHR – S**

Upside-down orientation for ceiling mounts

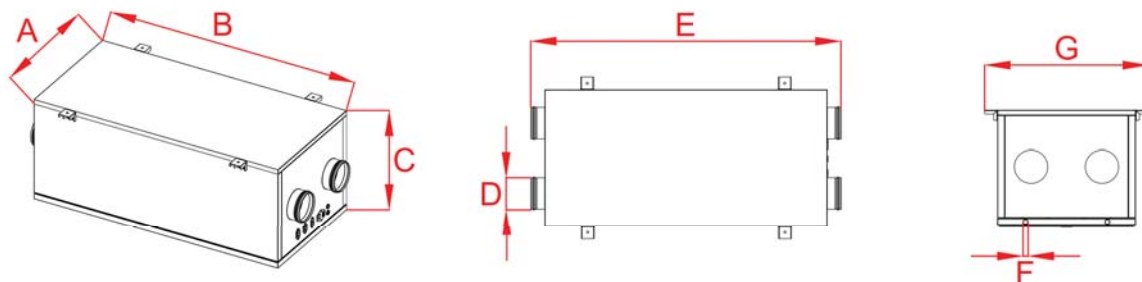

	A	B	C	D	E	F	G
<b>150 Slim</b>	496	1100	255	125	1210	20	596
<b>100S</b>	496	1100	355	125	1210	20	596
<b>150S</b>	496	1100	355	125	1210	20	596
<b>180S</b>	535	1100	455	125	1210	20	635
<b>325S</b>	535	1100	555	125	1210	20	635

## BSK BRHR – V

### Horizontal orientation for wall mounts

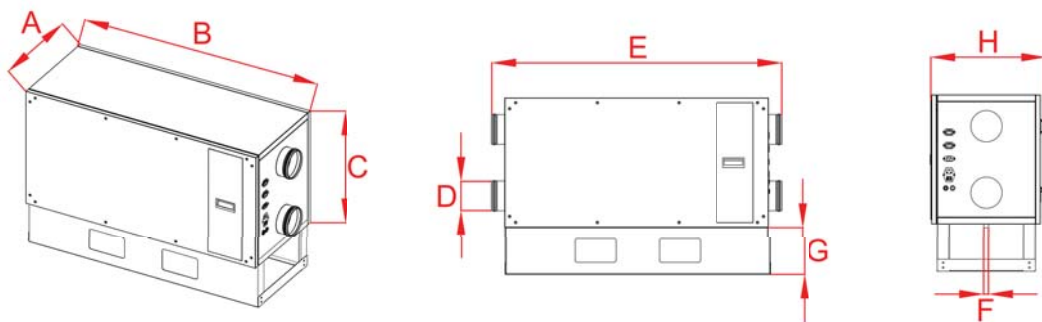

	A	B	C	D	E	F	G	H
100V	355	1100	496	125	1210	20	200	380
150V	405	1100	496	125	1210	20	200	430
180V	455	1100	535	125	1210	20	200	480
325V	590	1100	535	160	1210	20	200	610

## BSK BRHR – H

### Vertical orientation for wall or floor mounts

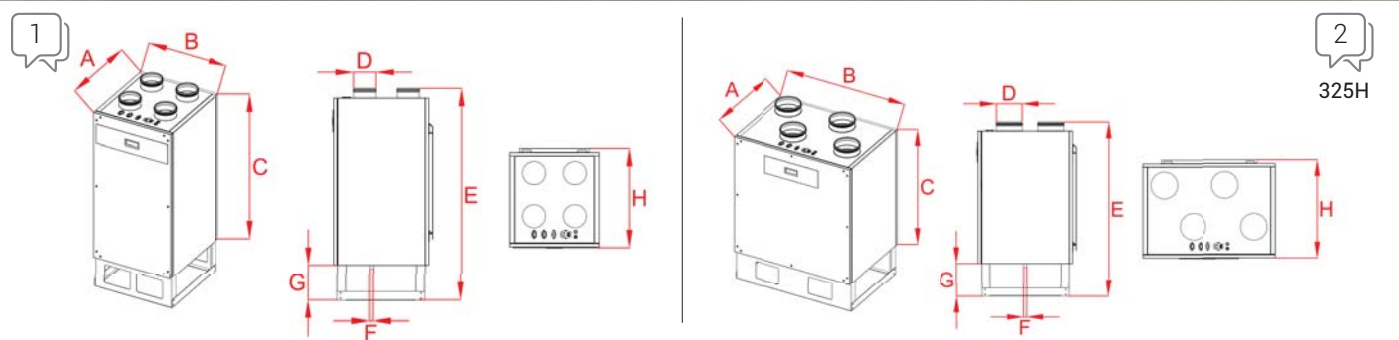

	A	B	C	D	E	F	G	H
100H	535	500	935	125	1190	20	200	560
150H	535	500	935	125	1190	20	200	560
180H	535	500	935	125	1190	20	200	560
220H	580	570	935	160	1190	20	200	605
325H	585	825	815	160	1070	20	200	610

# VENTI

## High capacity units with interchangeable airways

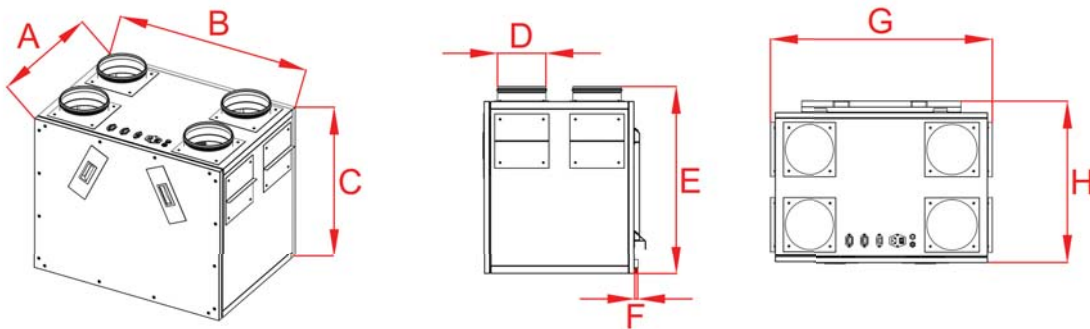

	A	B	C	D	E	F	G	H
Venti 400	555	785	635	160	690	11	820	597
Venti 500	555	785	635	180	690	11	820	597

## BRHR 150 Slim

Performance Graph

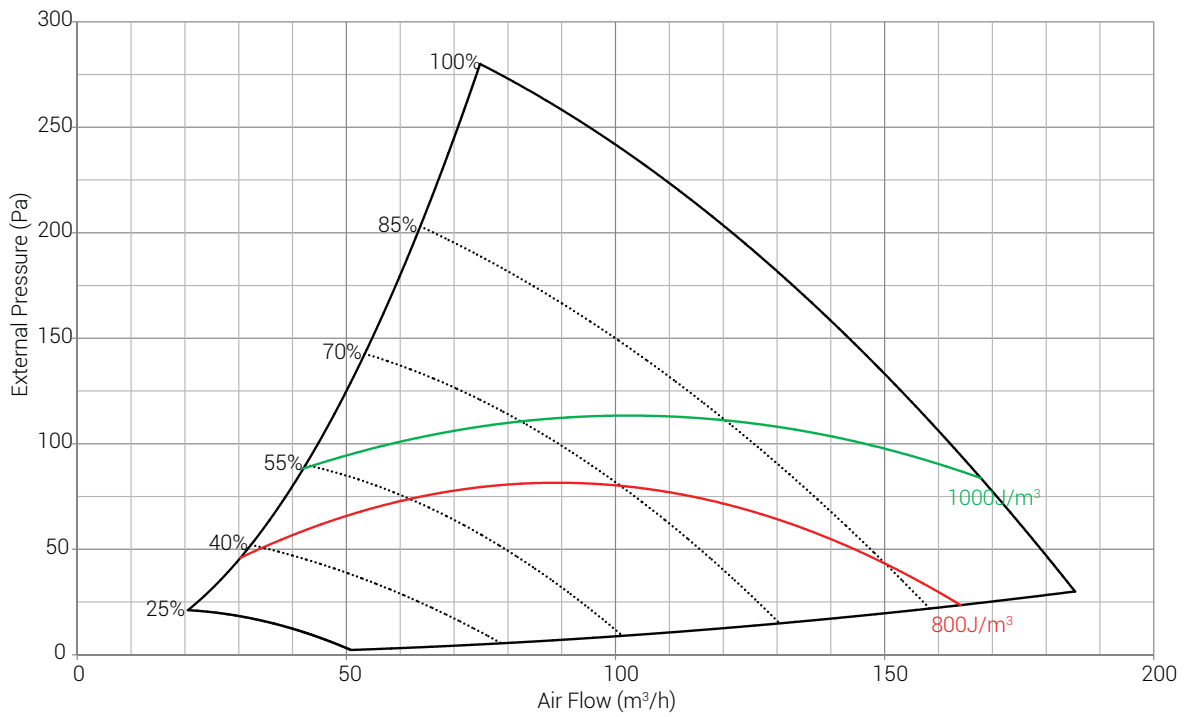

Temperature Effectiveness Graph

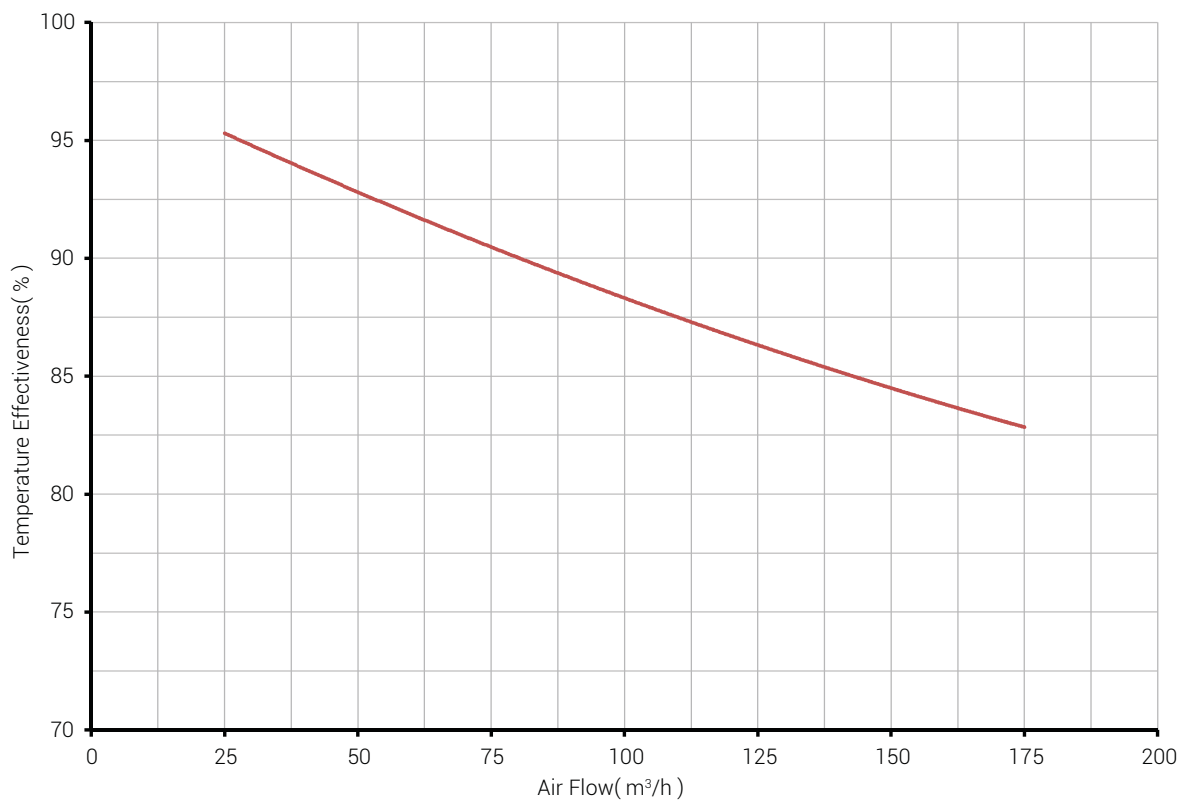

## BRHR 100

Performance Graph

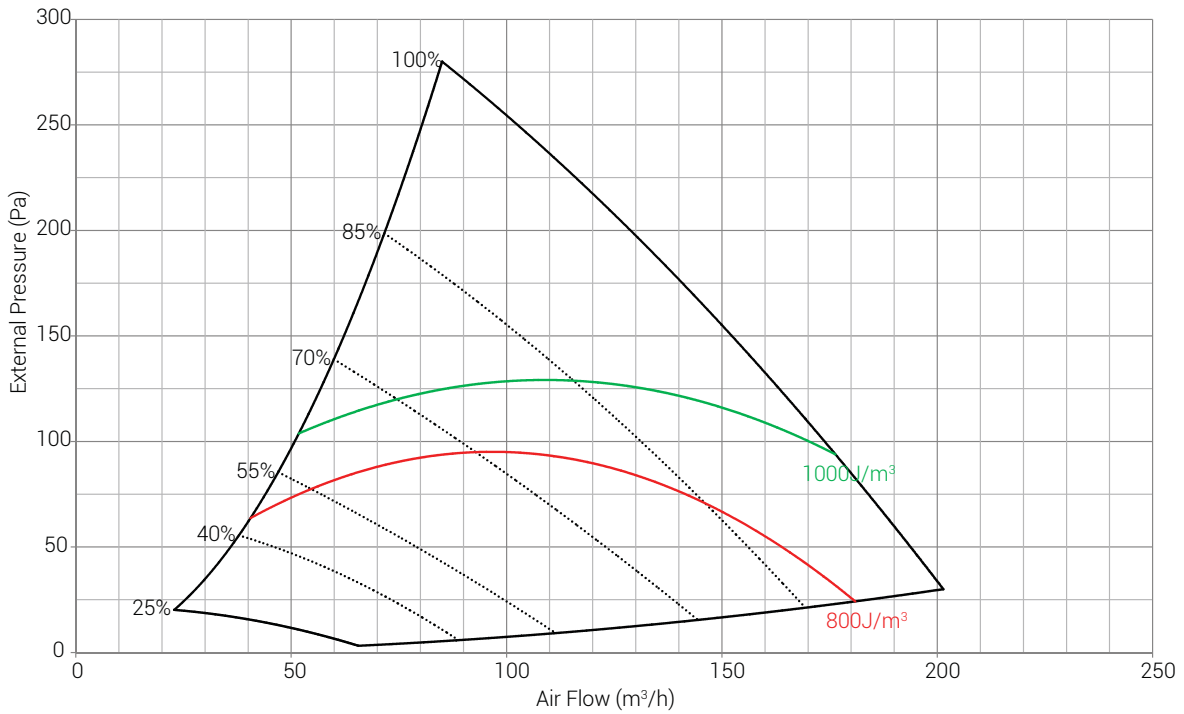

Temperature Effectiveness Graph

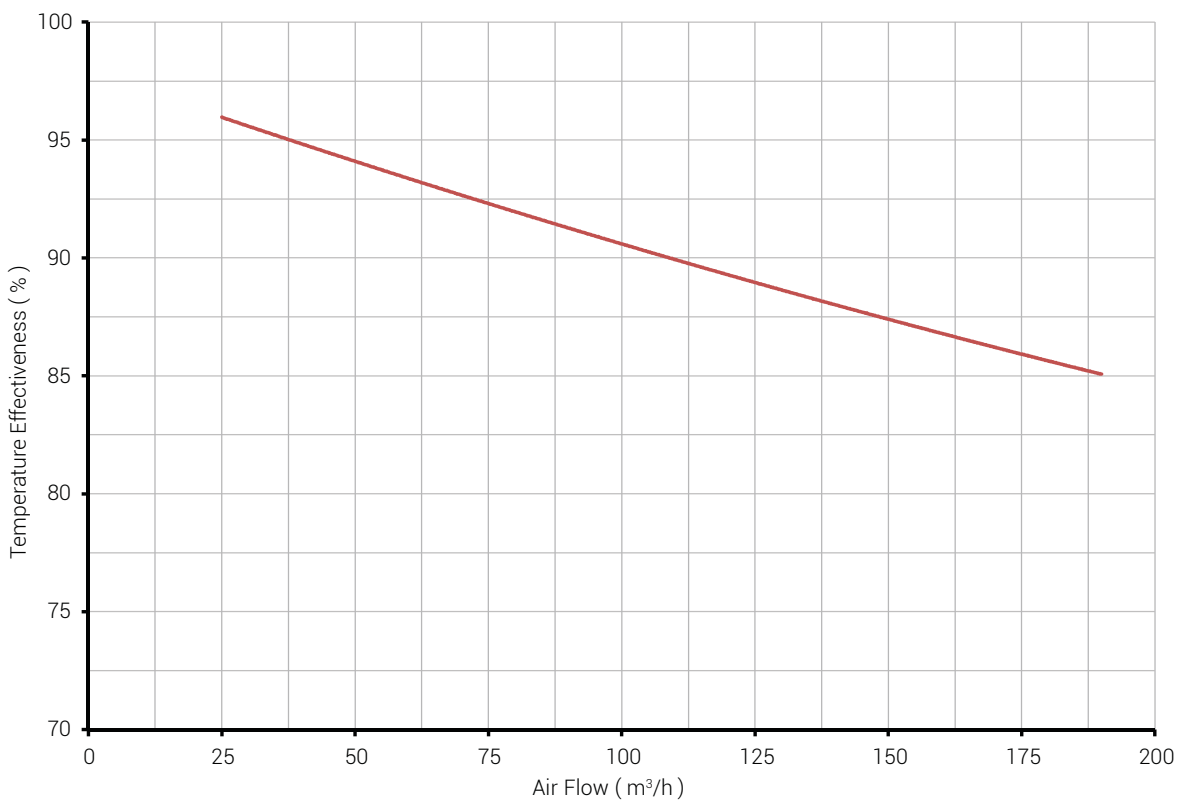

## BRHR 150

### Performance Graph

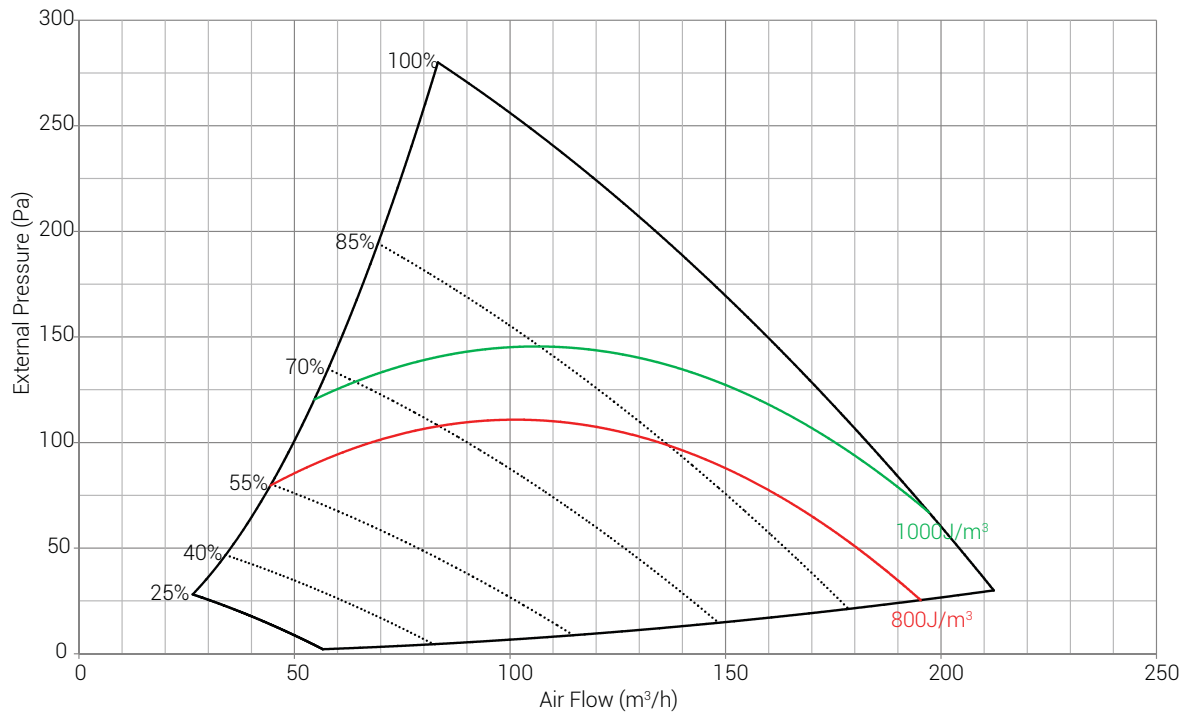

### Temperature Effectiveness Graph

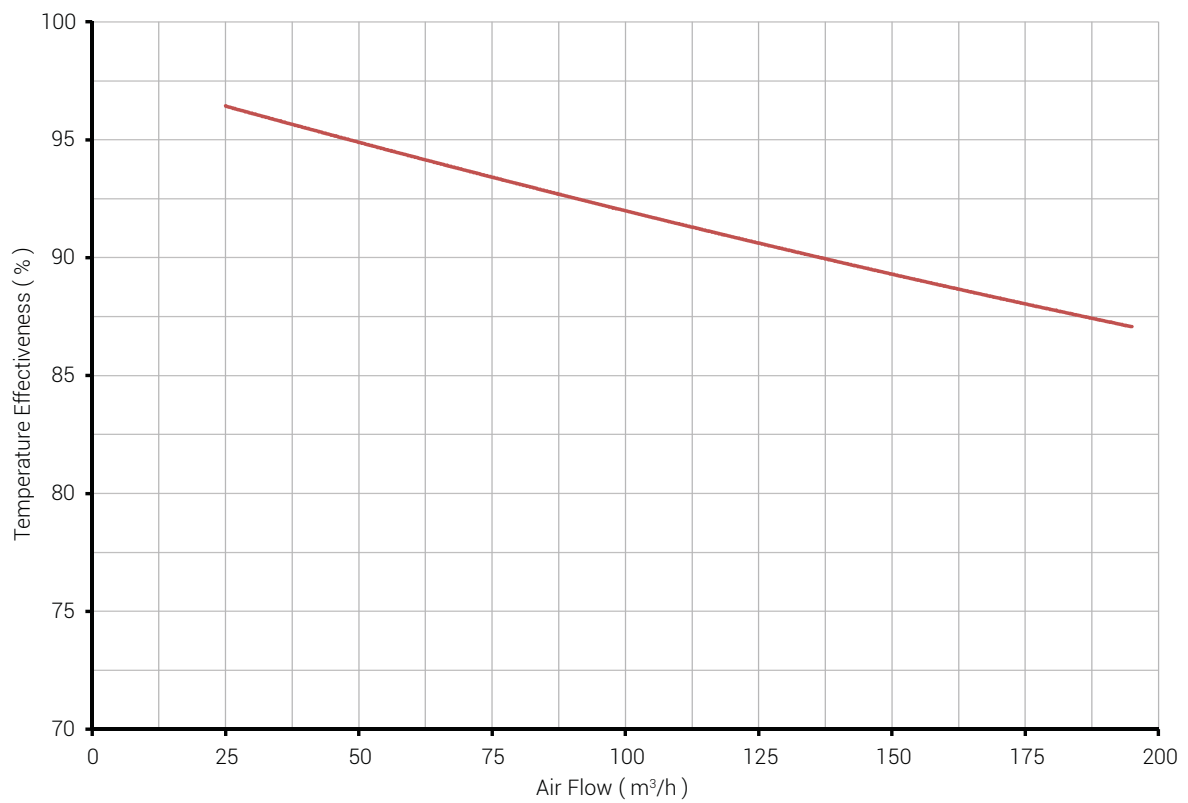



## BRHR 180

### Performance Graph

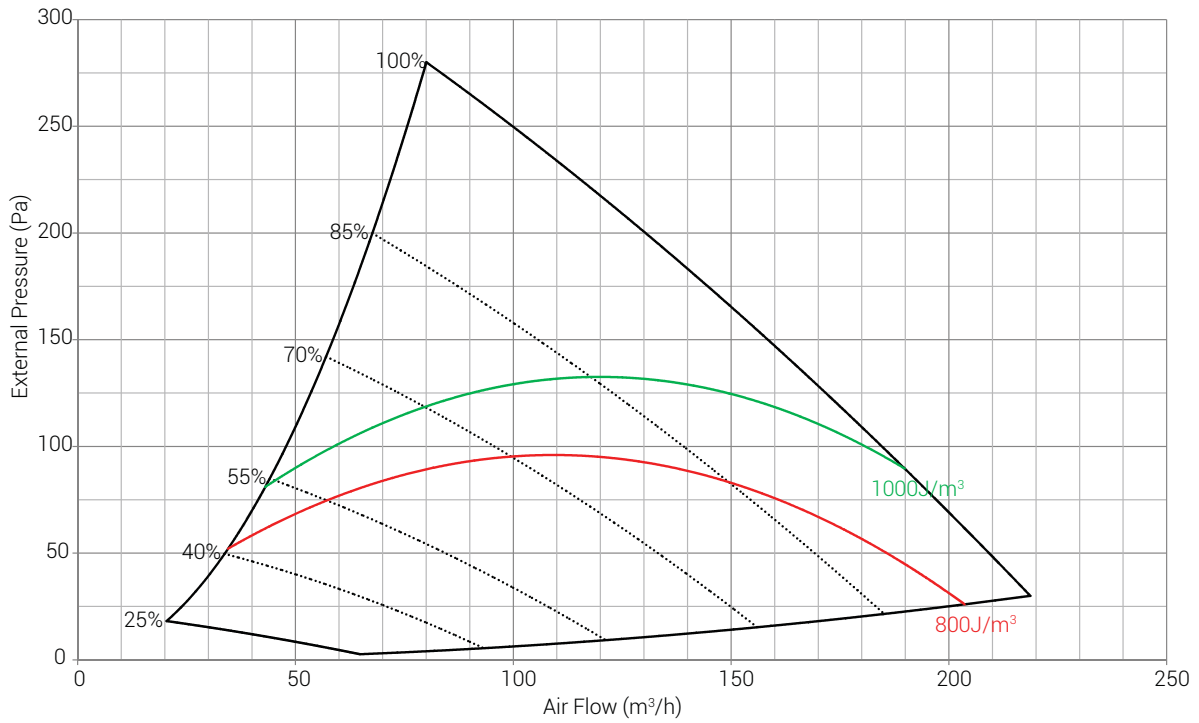

### Temperature Effectiveness Graph

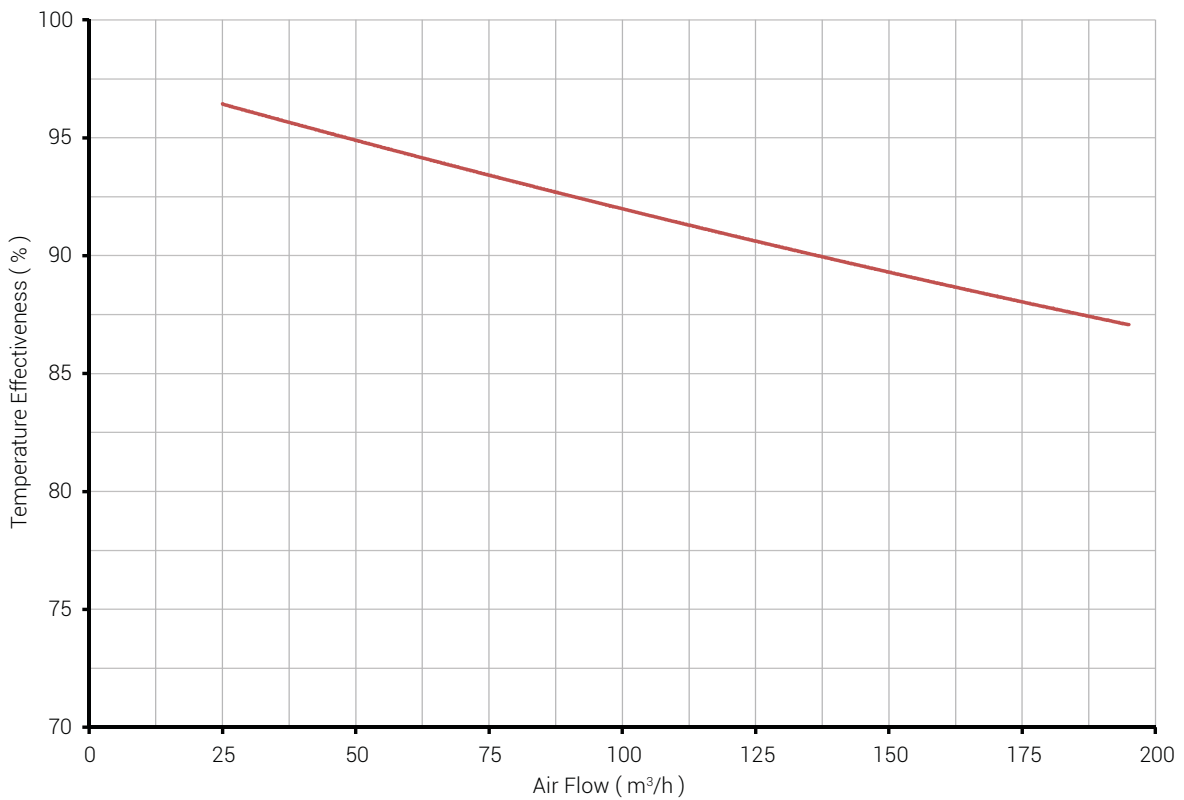

## BRHR 220

Performance Graph

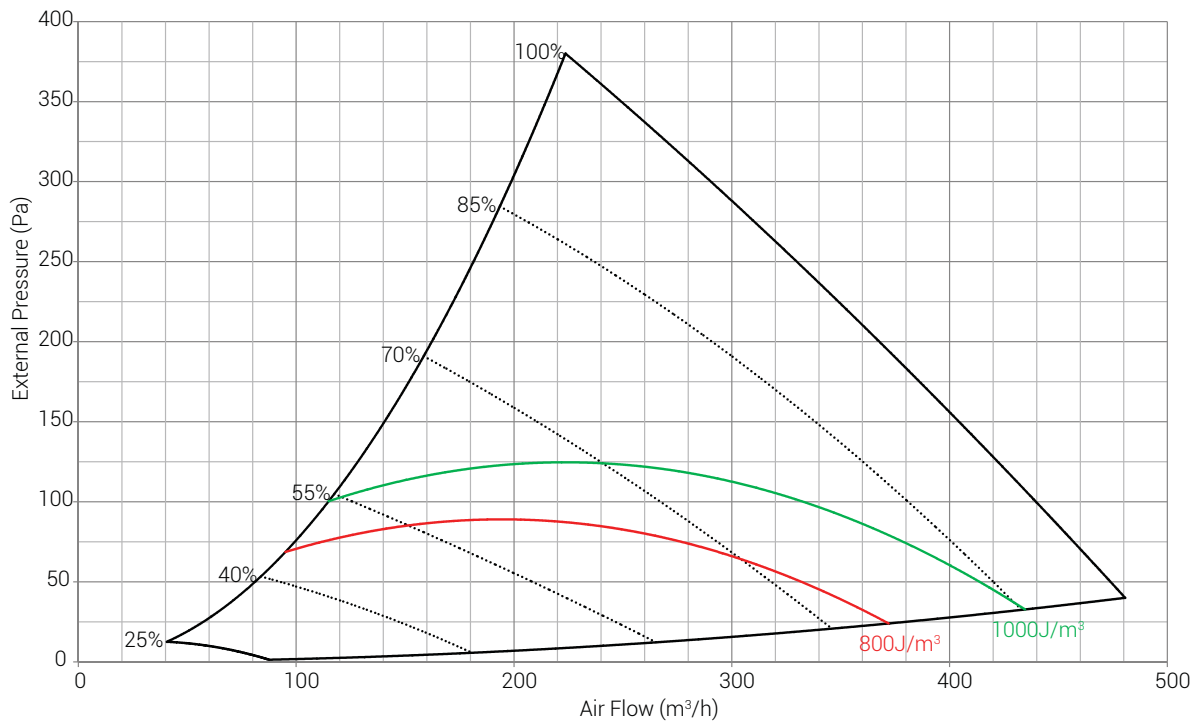

Temperature Effectiveness Graph

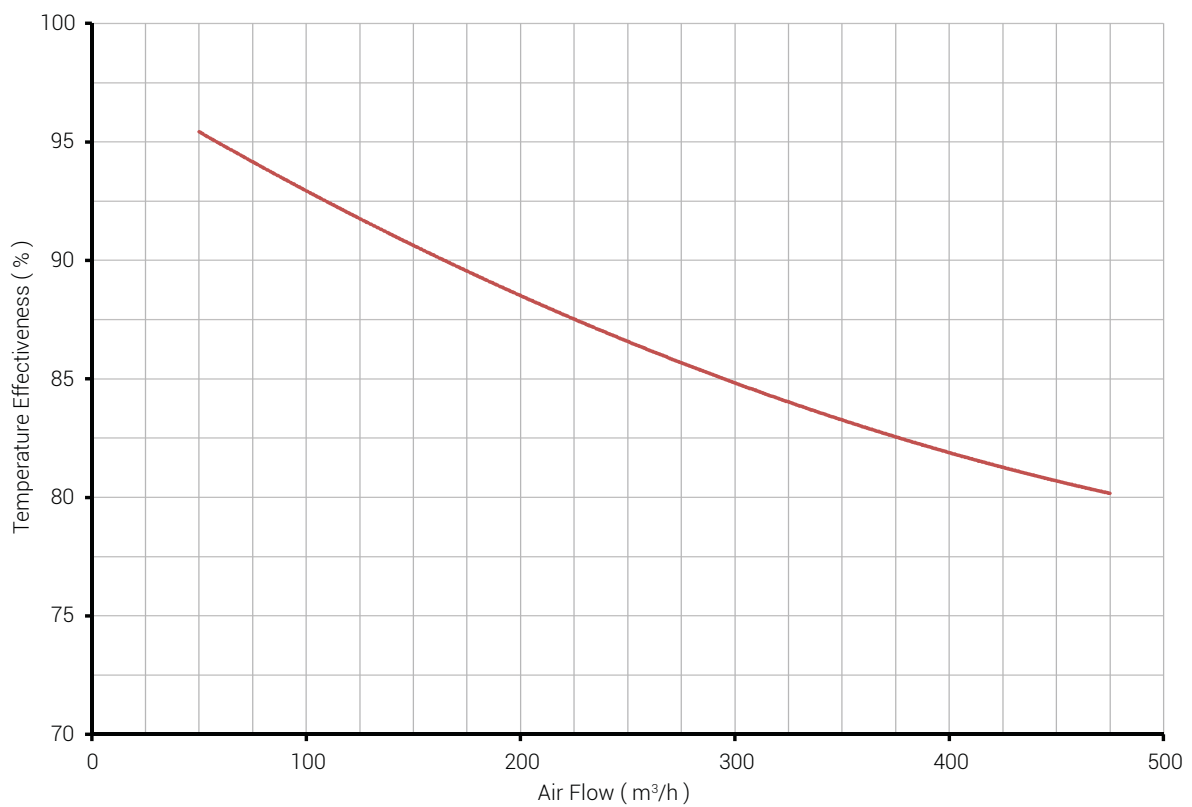

## BRHR 325

### Performance Graph

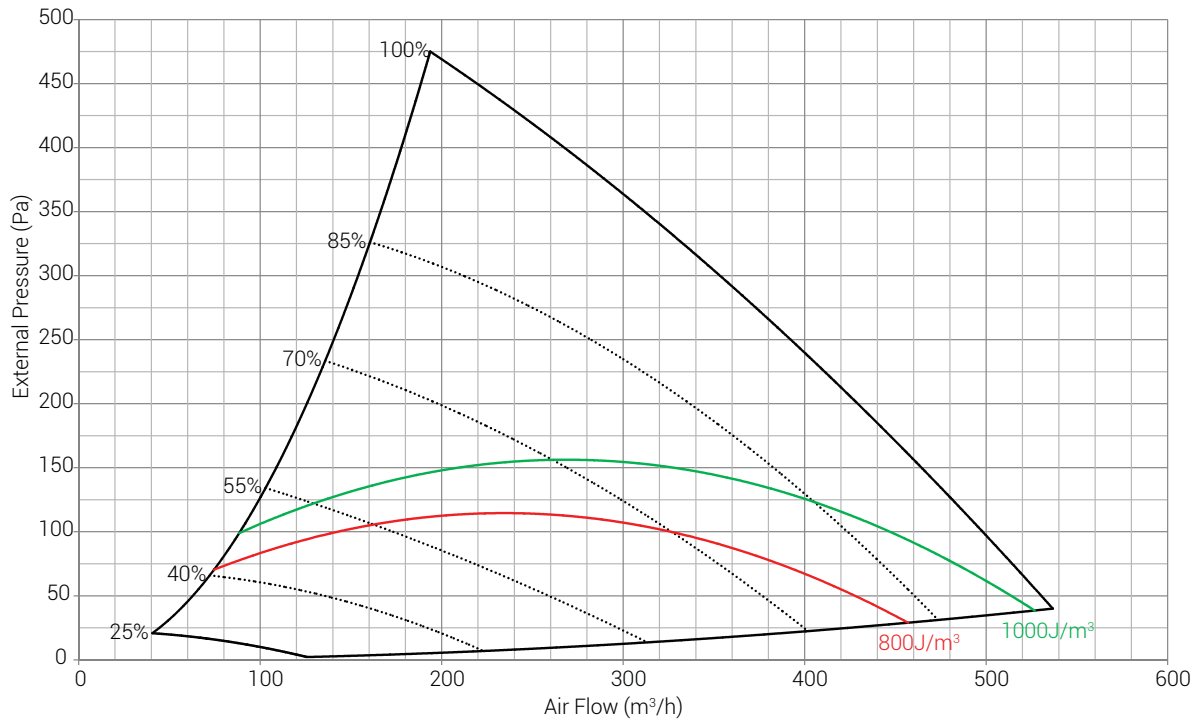

### Temperature Effectiveness Graph

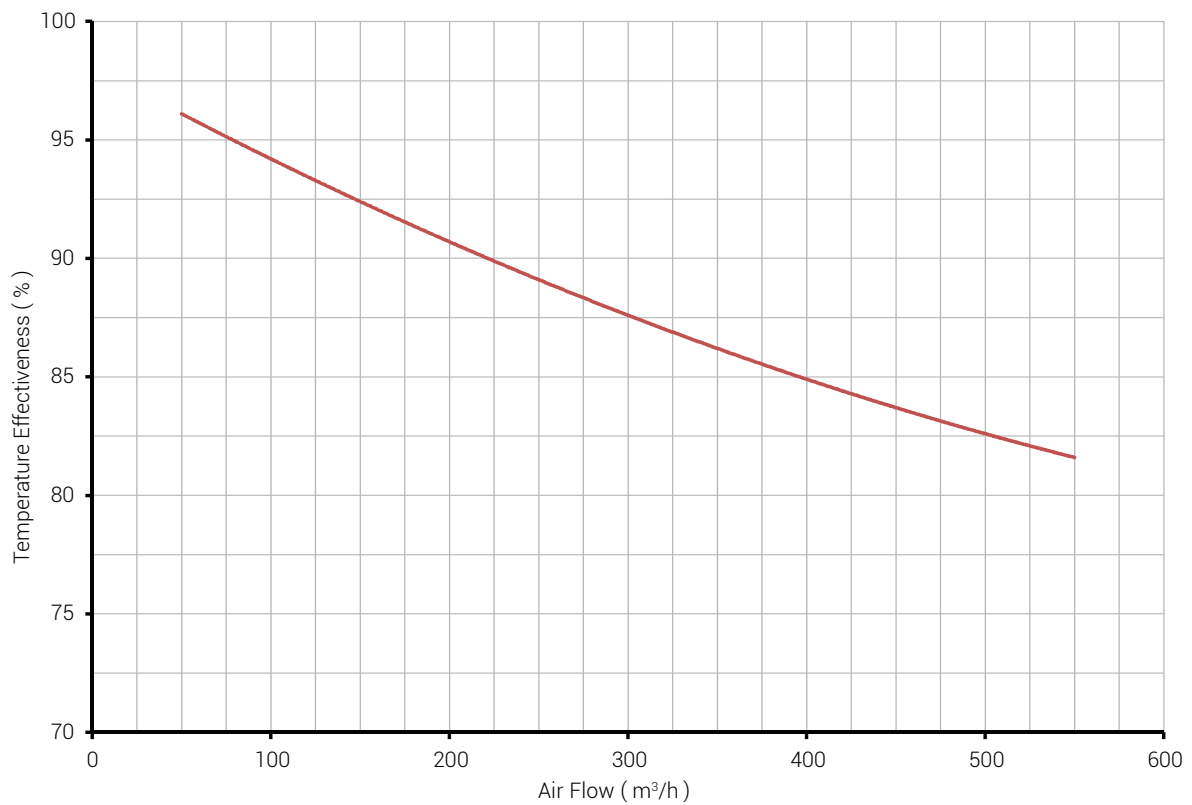

## VENTI 400

Performance Graph

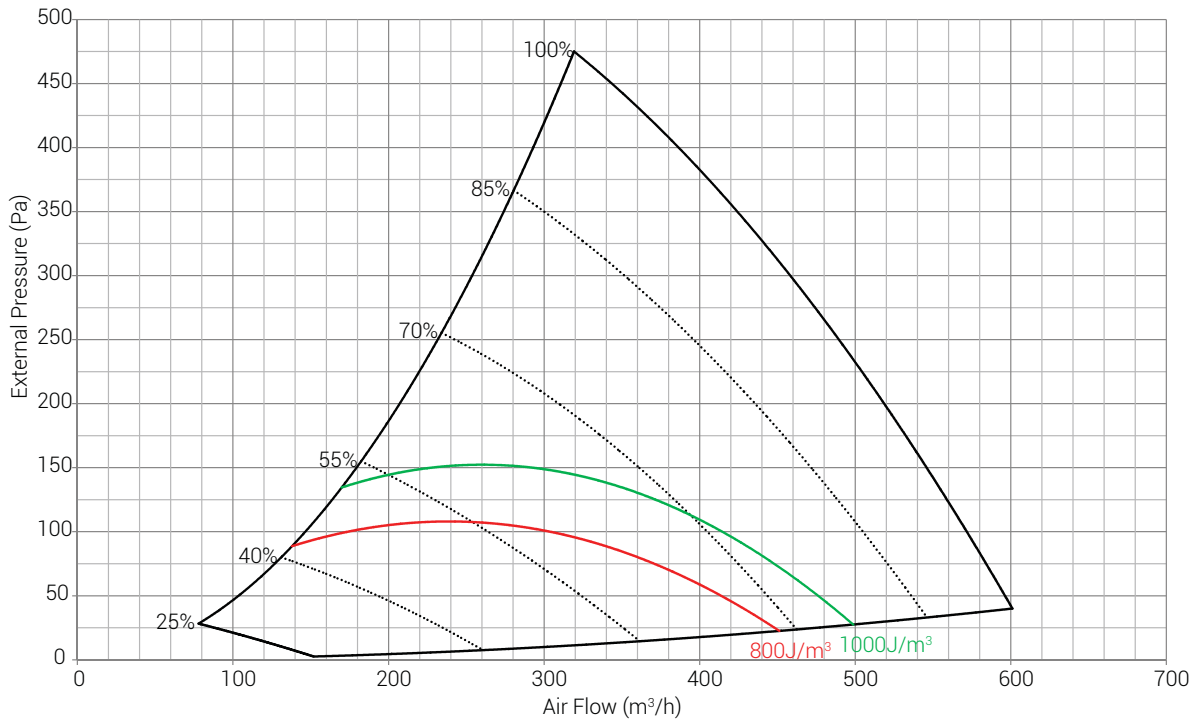

Temperature Effectiveness Graph

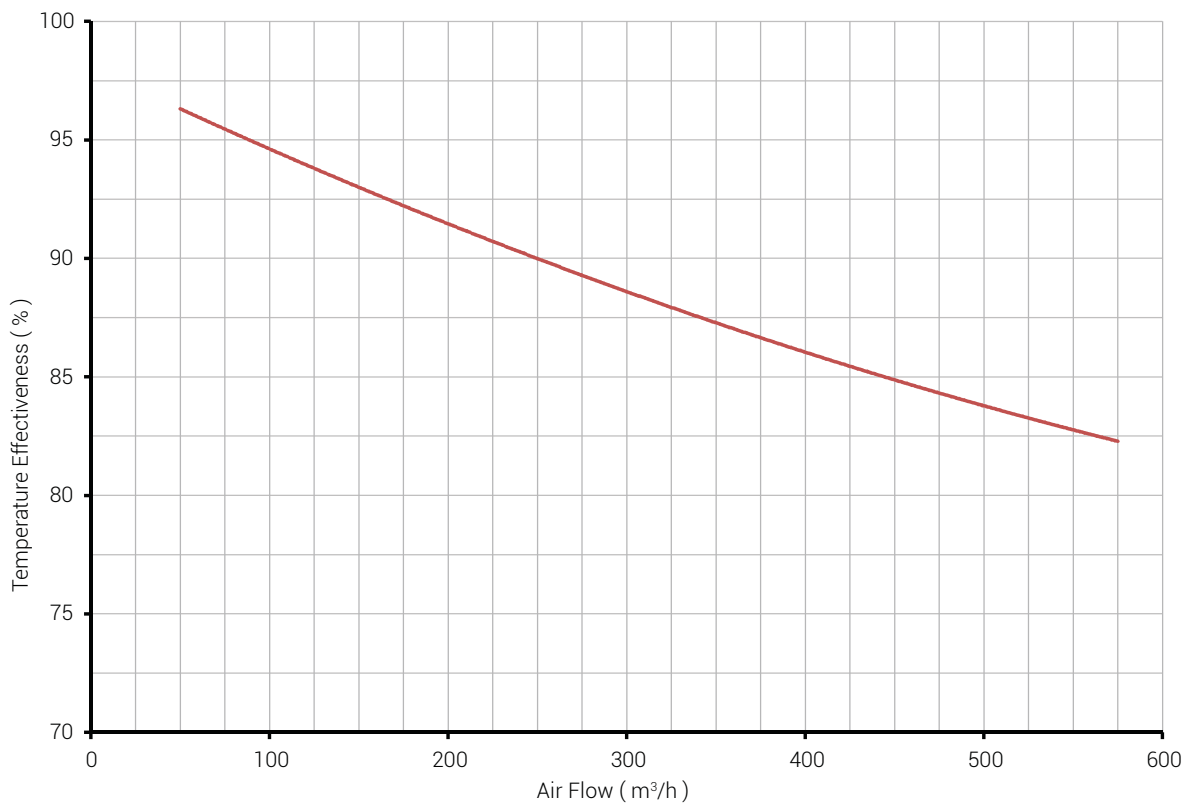

## VENTI 500

### Performance Graph

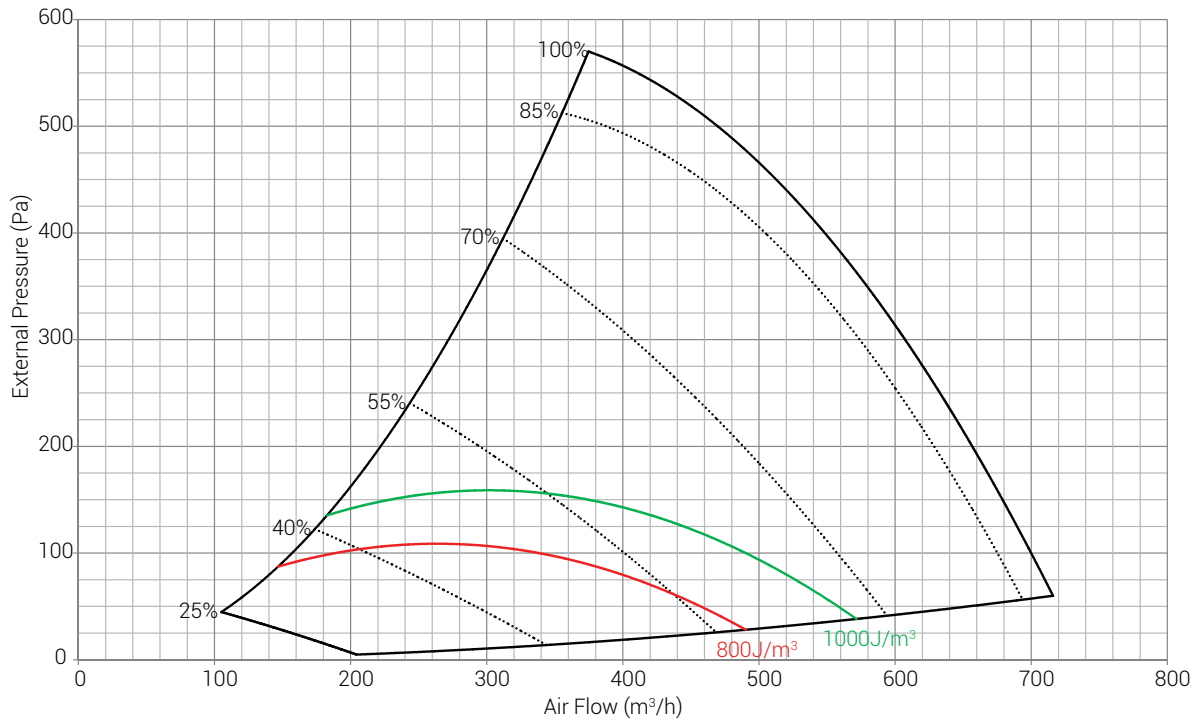

### Temperature Effectiveness Graph

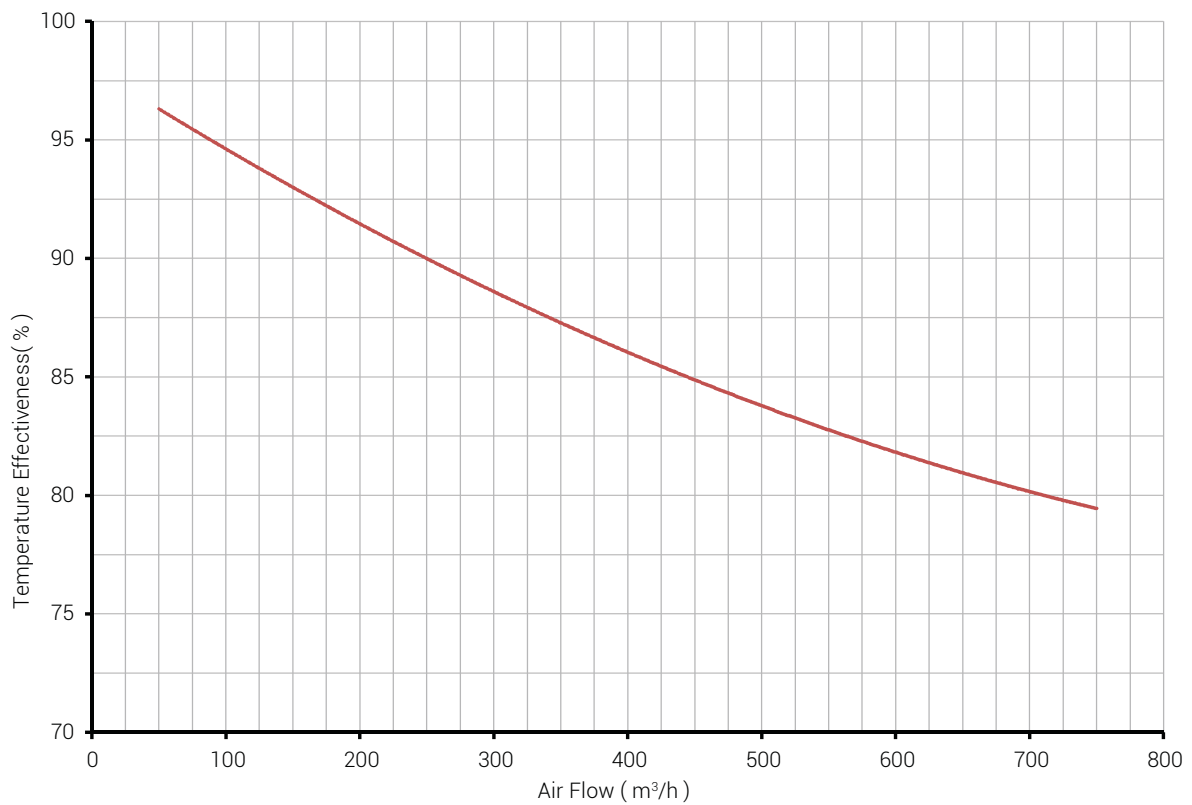







**BSK Ventilation Equipment INC.**

📍 Mimar Sinan mah. Basra cad. No: 59 / A Sultanbeyli,  
Istanbul TURKEY

☎ +90 (216) 669 09 70

🌐 [info@bskhavalandirma.com.tr](mailto:info@bskhavalandirma.com.tr)

[www.bskhvac.com](http://www.bskhvac.com)